

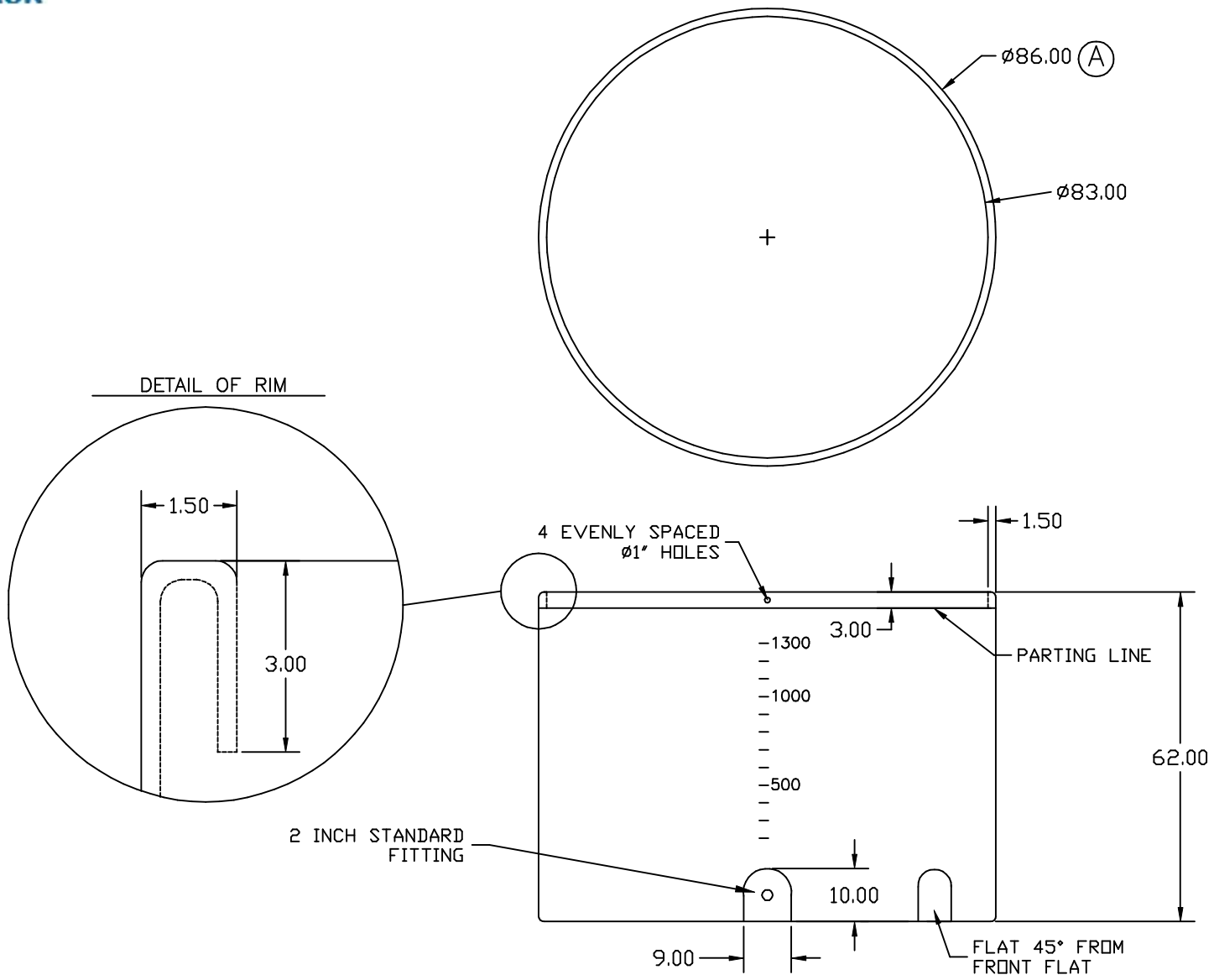

← GO BACK

TOP1350GAL-PE-86DIA

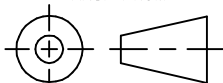

				DRAWN / DATE NVE 6/13/05	MATERIAL HDPE OR EQUIVALENT REFERENCE MATERIAL DATA SHEET FOR SPECIFIC PROPERTIES.	<div style="text-align: center;">   <b>ChemIndustrial Systems, Inc.</b>          PO Box 500, Cedarburg, WI 53012          262-375-8570 • (Fax) 262-375-8559 • info@chemindustrial.com       </div>	
A	DIA WAS 85, PN WAS OP1350-85	7/31/06	NVE	APPRD. / DATE DHJ 6/22/05			
REV	DESCRIPTION	DATE	APPRD				
ALL DIMENSIONS ARE IN DECIMAL INCHES TOLERANCES UNLESS OTHERWISE SPECIFIED $\pm 1\% \text{ @ } 68^\circ \text{ F}$				THIRD ANGLE PROJECTION ANSI 14.5M 	NOTES: 1. .260 WALL THICKNESS AT FITTING 2. SHOT WEIGHT 217 LBS.	SCALE N.S.	PART NO. TOP1350GAL-PE-86DIA